

Cambia

11 月 19 日

2018

---

Allen Bradley  
1756-DNB

Datasheet

## *Installation Instructions*

# **ControlLogix DeviceNet Scanner Module**

Catalog Numbers 1756-DNB, Series C and D

<b>Topic</b>	<b>Page</b>
Important User Information	2
Preventing Electrostatic Discharge	3
European Hazardous Location Approval - European Zone 2 Certification	4
Environment and Enclosure	5
North American Hazardous Location Approval	6
About this Publication	6
About the Module	7
Before You Begin	7
Determine Module Slot Location	8
Change Module Settings	9
Install the Module in the Chassis	16
Configure the Scan List	27
Monitor and Troubleshoot Devices in the Module Scan List	27
Interpret the Status Indicators	35
Understand ControlLogix Controller Interface Structures	38
Specifications	43
Additional Resources	47

### Important User Information

Solid state equipment has operational characteristics differing from those of electromechanical equipment. Safety Guidelines for the Application, Installation and Maintenance of Solid State Controls [Publication SGI-1.1](#) available from your local Rockwell Automation sales office or online at <http://literature.rockwellautomation.com> describes some important differences between solid state equipment and hard-wired electromechanical devices. Because of this difference, and also because of the wide variety of uses for solid state equipment, all persons responsible for applying this equipment must satisfy themselves that each intended application of this equipment is acceptable.





In no event will Rockwell Automation, Inc. be responsible or liable for indirect or consequential damages resulting from the use or application of this equipment.

The examples and diagrams in this manual are included solely for illustrative purposes. Because of the many variables and requirements associated with any particular installation, Rockwell Automation, Inc. cannot assume responsibility or liability for actual use based on the examples and diagrams.

No patent liability is assumed by Rockwell Automation, Inc. with respect to use of information, circuits, equipment, or software described in this manual.

Reproduction of the contents of this manual, in whole or in part, without written permission of Rockwell Automation, Inc., is prohibited.

Throughout this manual, when necessary, we use notes to make you aware of safety considerations.

<b>WARNING</b> 	Identifies information about practices or circumstances that can cause an explosion in a hazardous environment, which may lead to personal injury or death, property damage, or economic loss.
<b>IMPORTANT</b>	Identifies information that is critical for successful application and understanding of the product.
<b>ATTENTION</b> 	Identifies information about practices or circumstances that can lead to personal injury or death, property damage, or economic loss. Attentions help you identify a hazard, avoid a hazard and recognize the consequences.
<b>SHOCK HAZARD</b> 	Labels may be on or inside the equipment (for example, a drive or motor) to alert people that dangerous voltage may be present.
<b>BURN HAZARD</b> 	Labels may be on or inside the equipment (for example, a drive or motor) to alert people that surfaces may reach dangerous temperatures.

---

## Preventing Electrostatic Discharge

---

**ATTENTION**

This equipment is sensitive to electrostatic discharge, which can cause internal damage and affect normal operation. Follow these guidelines when you handle this equipment:

- Touch a grounded object to discharge potential static.
  - Wear an approved grounding wriststrap.
  - Do not touch connectors or pins on component boards.
  - Do not touch circuit components inside the equipment.
  - Use a static-safe workstation, if available.
  - Store the equipment in appropriate static-safe packaging when not in use.
-

### European Hazardous Location Approval - European Zone 2 Certification

The following applies when the product bears the EEx Marking).

This equipment is intended for use in potentially explosive atmospheres as defined by European Union Directive 94/9/EC.

The LCIE (Laboratoire Central des Industries Electriques) certifies that this equipment has been found to comply with the Essential Health and Safety Requirements relating to the design and construction of Category 3 equipment intended for use in potentially explosive atmospheres, given in Annex II to this Directive.

Compliance with the Essential Health and Safety Requirements has been assured by compliance with EN 60079-15.

---

**IMPORTANT**

- This equipment is not resistant to sunlight or other sources of UV radiation.
  - This equipment must be installed in an enclosure providing at least IP54 protection when applied in Class I, Zone 2 environments.
  - This equipment shall be used within its specified ratings defined by Rockwell Automation.
  - Provision shall be made to prevent the rated voltage from being exceeded by transient disturbances of more than 40% when applied in Class I, Zone 2 environments.
  - This equipment must be used only with ATEX certified backplanes.
-

---

## Environment and Enclosure

---

**ATTENTION**

This equipment is intended for use in a Pollution Degree 2 industrial environment, in overvoltage Category II applications (as defined in IEC publication 60664-1), at altitudes up to 2000 m (6562 ft) without derating.



This equipment is considered Group 1, Class A industrial equipment according to IEC/CISPR Publication 11. Without appropriate precautions, there may be potential difficulties ensuring electromagnetic compatibility in other environments due to conducted as well as radiated disturbance.

This equipment is supplied as open-type equipment. It must be mounted within an enclosure that is suitably designed for those specific environmental conditions that will be present and appropriately designed to prevent personal injury resulting from accessibility to live parts. The enclosure must have suitable flame-retardant properties to prevent or minimize the spread of flame, complying with a flame spread rating of 5VA, V2, V1, V0 (or equivalent) if non-metallic. The interior of the enclosure must be accessible only by the use of a tool. Subsequent sections of this publication may contain additional information regarding specific enclosure type ratings that are required to comply with certain product safety certifications.

Besides this publication, see:

- Industrial Automation Wiring and Grounding Guidelines, for additional installation requirements, Allen-Bradley publication [1770-4.1](#).
  - NEMA Standards publication 250 and IEC publication 60529, as applicable, for explanations of the degrees of protection provided by different types of enclosure.
-

## North American Hazardous Location Approval

<p><b>The following information applies when operating this equipment in hazardous locations.</b></p>	<p><b>Informations sur l'utilisation de cet équipement en environnements dangereux.</b></p>		
<p>Products marked "CL I, DIV 2, GP A, B, C, D" are suitable for use in Class I Division 2 Groups A, B, C, D, Hazardous Locations and nonhazardous locations only. Each product is supplied with markings on the rating nameplate indicating the hazardous location temperature code. When combining products within a system, the most adverse temperature code (lowest "T" number) may be used to help determine the overall temperature code of the system. Combinations of equipment in your system are subject to investigation by the local Authority Having Jurisdiction at the time of installation.</p>	<p>Les produits marqués "CL I, DIV 2, GP A, B, C, D" ne conviennent qu'à une utilisation en environnements de Classe I Division 2 Groupes A, B, C, D dangereux et non dangereux. Chaque produit est livré avec des marquages sur sa plaque d'identification qui indiquent le code de température pour les environnements dangereux. Lorsque plusieurs produits sont combinés dans un système, le code de température le plus défavorable (code de température le plus faible) peut être utilisé pour déterminer le code de température global du système. Les combinaisons d'équipements dans le système sont sujettes à inspection par les autorités locales qualifiées au moment de l'installation.</p>		
<p><b>WARNING</b></p> 	<p><b>EXPLOSION HAZARD -</b></p> <ul style="list-style-type: none"> <li>Do not disconnect equipment unless power has been removed or the area is known to be nonhazardous.</li> <li>Do not disconnect connections to this equipment unless power has been removed or the area is known to be nonhazardous. Secure any external connections that mate to this equipment by using screws, sliding latches, threaded connectors, or other means provided with this product.</li> <li>Substitution of components may impair suitability for Class I, Division 2.</li> <li>If this product contains batteries they must only be changed in an area known to be nonhazardous.</li> </ul>	<p><b>AVERTISSEMENT</b></p> 	<p><b>RISQUE D'EXPLOSION -</b></p> <ul style="list-style-type: none"> <li>Couper le courant ou s'assurer que l'environnement est classé non dangereux avant de débrancher l'équipement.</li> <li>Couper le courant ou s'assurer que l'environnement est classé non dangereux avant de débrancher les connecteurs. Fixer tous les connecteurs externes reliés à cet équipement à l'aide de vis, loquets coulissants, connecteurs filetés ou autres moyens fournis avec ce produit.</li> <li>La substitution de composants peut rendre cet équipement inadapté à une utilisation en environnement de Classe I, Division 2.</li> <li>S'assurer que l'environnement est classé non dangereux avant de changer les piles.</li> </ul>

### About this Publication

Use this publication as a guide to install the module. This publication describes hardware installation only. For configuration information, refer to the DeviceNet Modules in Logix5000 Systems User Manual, publication [DNET-UM004](#).

## About the Module

Use this figure to identify the external features of the module.

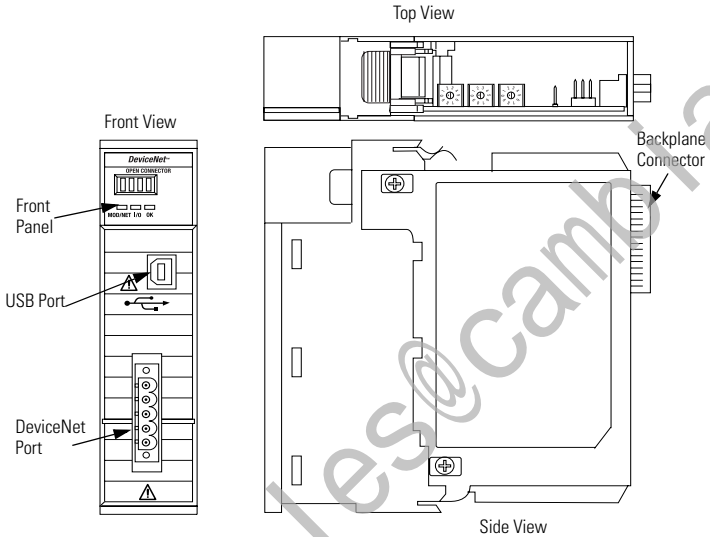

31713-M

## Before You Begin

Before you install the module, you must install and connect a ControlLogix chassis and power supply.

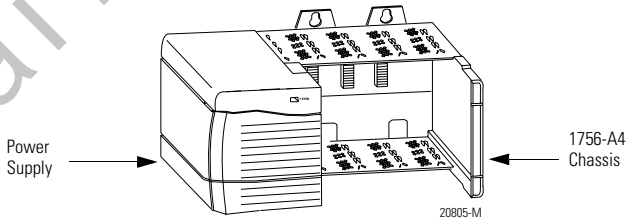

20805-M



To install these products, refer to these publications.

### Publication References

Chassis Type	Chassis Installation Instructions	Power Supply	Power Supply Installation Instructions
Series B: 1756-A4, 1756-A7, 1756-A10, 1756-A13	Pub. No. <a href="#">1756-IN080</a>	1756-PA72/B	Pub. No. <a href="#">1756-IN078</a>
		1756-PB72/B	
	1756-PA75/A	Pub. No. <a href="#">1756-IN596</a>	
	1756-PB75/A		

### Determine Module Slot Location

Install the module in any slot in the ControlLogix chassis. You can install multiple 1756-DNB scanner modules in the same chassis.

The following figure shows chassis slot numbering in a 4-slot chassis. Slot 0 is the first slot and is always the leftmost slot in the chassis.

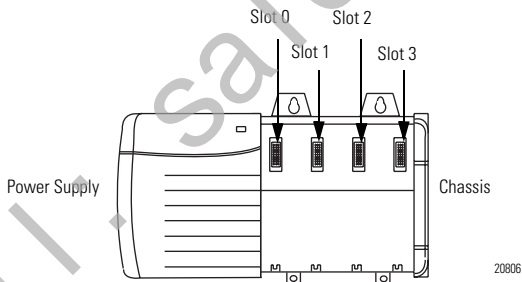

## Change Module Settings

The module ships with these settings.

### Factory Setting Values

Factory Settings	Value
Rotary switches	999
Communication (data) rate	Software settable (default 125 Kbps)
Node address	Software settable (default 63)

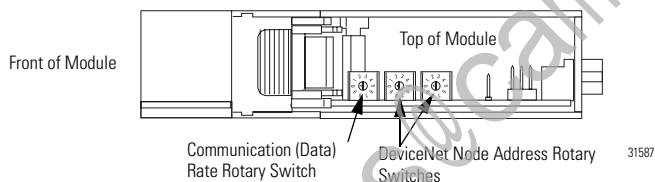

### Set the Communication Rate

The 1756-DNB scanner module supports the following DeviceNet network communication rates:

- 125 Kbps
- 250 Kbps
- 500 Kbps

The factory default setting is 125 Kbps.

---

**ATTENTION**

Do not change the communication rate on an active network. Unpredictable operation may result. In addition, the new communication rate does not take effect until you cycle power to the 1756-DNB scanner module.

---

Change the communication rate by setting the rotary switch or commissioning the 1756-DNB scanner module in RSNetWorx for DeviceNet software.

Use the switch to select a specific communication rate. When the switch is set to 3...9 (except for 888), you can configure the communication rate with RSNetWorx for DeviceNet software. When all three switches are set to 8, the 1756-DNB scanner module will reset to factory default settings at powerup.

See Restore the Factory Default Settings on [page 15](#) for more information.

See the following table for switch settings.

## Communication Rate Rotary Switch

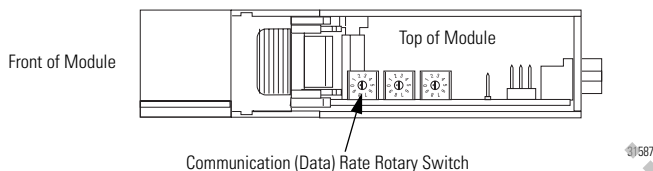

### Switch Settings and Communication Rate

Switch Setting	Communication Rate
0	125 Kbps
1	250 Kbps
2	500 Kbps
8	When all three switches are set to 8, this resets the 1756-DNB scanner module to factory default settings. Do not use for normal operation.
All other values	Select the communication rate with RSNetWorx for DeviceNet software.

### *Set the Rotary Switch*

Use the communication (data) rate rotary switch to change the communication rate.

**TIP**

For ease of access, remove the module from the chassis before proceeding.

1. If the module is removed from the chassis, be sure that power is removed or the area is nonhazardous before proceeding.
2. Move the rotary switch to the desired position.
3. If necessary, reinstall the module into the chassis.

### *Use RSNetWorx for DeviceNet Software*

Follow this procedure to use RSNetWorx for DeviceNet software to set the communication rate.

For more information, refer to the DeviceNet Modules in Logix5000 Control Systems User Manual, publication [DNET-UM004](#).

1. In RSNetWorx for DeviceNet software, select the 1756-DNB scanner module.
2. Select Tools and Node Commissioning.
3. Browse to the DeviceNet network for the 1756-DNB scanner module you want to commission.
4. Select the 1756-DNB scanner module you want to commission.

5. In the Data Rate field, select the communication (data) rate.
6. Click Apply.
7. Cycle power to the 1756-DNB scanner module.

## Set the Node Address

The 1756-DNB scanner module supports DeviceNet node addresses 00...63. The factory default setting is node address 63.

Change the node address by setting the rotary switches or commissioning the 1756-DNB scanner module in RSNetWorx for DeviceNet software.

Use the switches to select any network address from 00 through 63. When the switches are set outside of this range (except for 888), you can configure the node address with RSNetWorx for DeviceNet software. When all three switches are set to 8, the 1756-DNB scanner module will reset to factory default settings at powerup. See [Restore the Factory Default Settings on page 15](#) for more information. See the following table for switch settings.

## Switch Settings

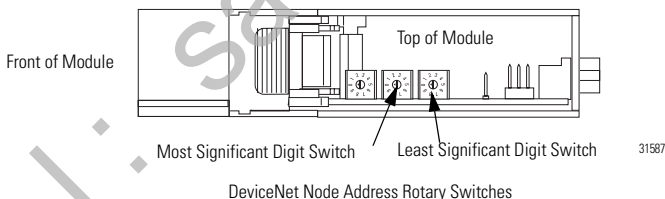

## Switch Settings

Switch Setting	Node Address
0...63	DeviceNet node address 00...63
88	When all three switches are set to 8, resets the 1756-DNB scanner module to factory default settings. Do not use for normal operation.
All other values	Select the node address with RSNetWorx for DeviceNet software.

### *Set the Rotary Switches*

Use the node address rotary switches to change the DeviceNet node address for the 1756-DNB scanner module.

**TIP**

For ease of access, remove the module from the chassis before proceeding.

1. If the module is removed from the chassis, be sure that power is removed or the area is nonhazardous before proceeding.
2. Move the rotary switches to the desired position.
3. If necessary, reinstall the module into the chassis.

### *Use RSNetWorx for DeviceNet Software*

Follow this procedure to use RSNetWorx for DeviceNet software to set the node address.

For more information, refer to DeviceNet Modules in Logix5000 Control Systems, publication [DNET-UM004](#).

1. In RSNetWorx for DeviceNet software, select the 1756-DNB scanner module.
2. Click Tools>Node Commissioning.
3. Browse to the DeviceNet network for the 1756-DNB scanner module you want to commission.
4. Select the 1756-DNB scanner module you want to commission.
5. In the Address field, select the node address.
6. Click Apply.

## Restore the Factory Default Settings

The out-of-box reset will clear the scanlist (including ADR configuration recovery files) and return all software setting attributes to their default values.

Follow this procedure to restore the factory default communication rate and node address.

1. Set the switches to 888.

---

**IMPORTANT**

Do not use the 888 switch setting during normal module operation.

---

2. Restore power to the module.

When the out-of-box reset is complete, the alphanumeric display repeatedly scrolls the message Reset Complete - Change Switch Settings. During this time, the module does not respond to communication from any port (including the backplane, DeviceNet connector, or USB port).

3. After the module resets, perform the following steps.
  - a. Set the switches to the desired position.
  - b. Restore power to the module.



## Install the Module in the Chassis

**WARNING**



When you insert or remove the module while backplane power is on, an electrical arc can occur. This could cause an explosion in hazardous location installations. Be sure that power is removed or the area is nonhazardous before proceeding. Repeated electrical arcing causes excessive wear to contacts on both the module and its mating connector. Worn contacts may create electrical resistance that can affect module operation.

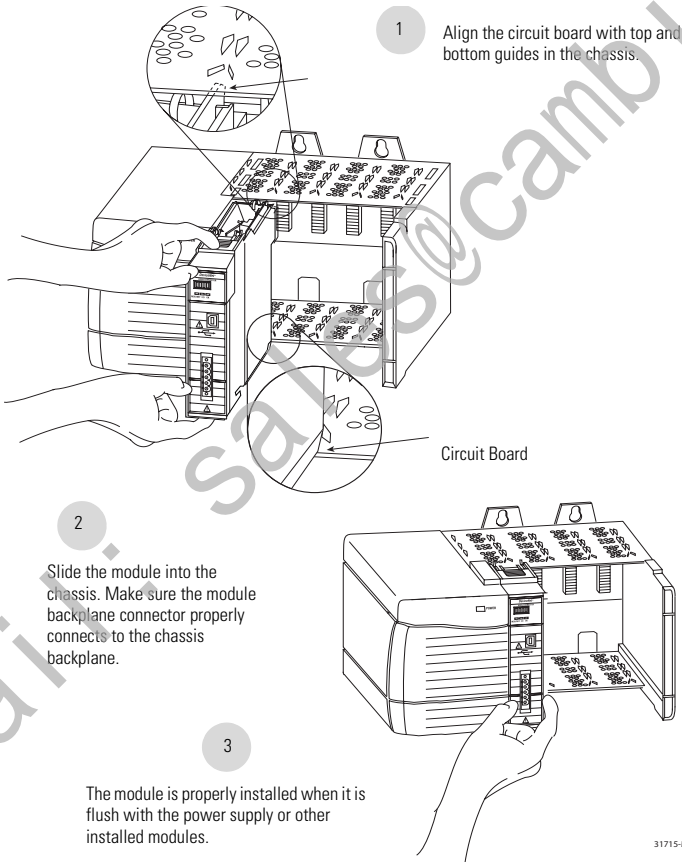

31715-M

## Wire the DeviceNet Connector

Use an open-style 5- or 10-position linear plug to connect to the DeviceNet network. An open-style 10-position linear plug is provided with your module.

**IMPORTANT**

For detailed DeviceNet connection information, see the DeviceNet Media Design and Installation Guide, publication [DNET-UM072](#). Also see the Industrial Automation Wiring and Grounding Guidelines, publication [1770-2.1](#).

Wire the connector according to the following illustrations.

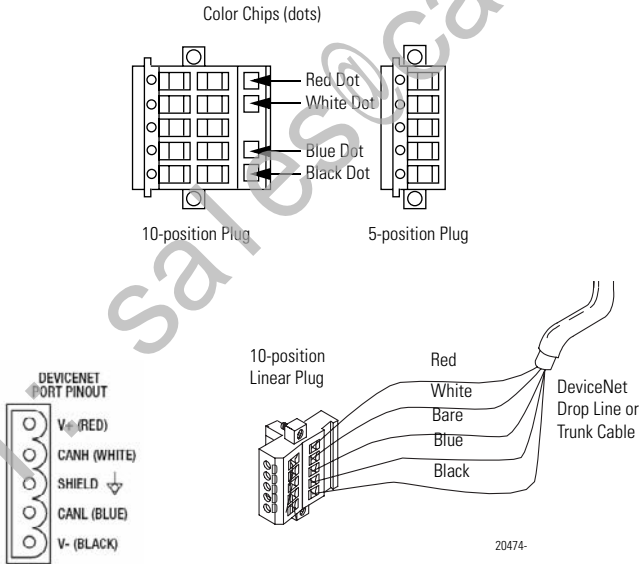

## Connect the Module to the DeviceNet Network

**WARNING**



If you connect or disconnect the DeviceNet connector with power applied to this module or any device on the network, an electrical arc can occur. This could cause an explosion in hazardous location installations. Be sure that power is removed or the area is nonhazardous before proceeding.

Attach the connector to the module's DeviceNet port as shown below. Tighten the screws on the connector as needed.

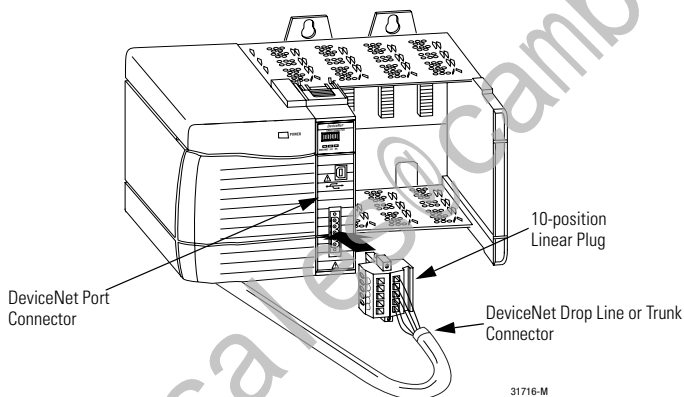

---

## Connect to the Module Via the USB Port

---

**WARNING**

The USB port is intended for temporary local programming purposes only and is not intended for permanent connection. If you connect or disconnect the USB cable with power applied to this module or any device on the USB network, an electrical arc can occur. This could cause an explosion in hazardous location installations.

Be sure that power is removed or the area is nonhazardous before proceeding. A Samtec Inc. RSP-119350 USB cable is required to maintain hazardous location certifications.

---

The module has a USB device port that uses a Series B receptacle. To use the USB port, you must have RSLinx software, version 2.51 or higher, installed on your computer.

Use a USB cable to connect your computer to the USB port. The connection lets you download programs to controllers and configure modules directly from your computer.

---

**IMPORTANT**

- The USB port is designed for a temporary connection only.
  - The USB cable is not to exceed 3.0 m (9.84 ft) and must not contain hubs.
- 

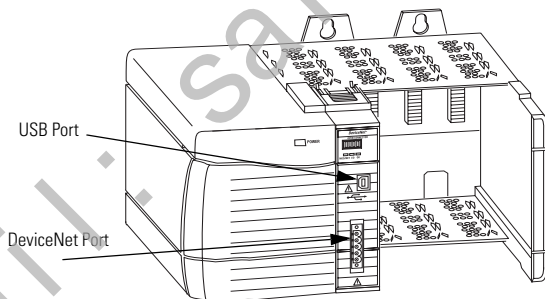

31592-M

## Set Up the USB Driver

**IMPORTANT**

The 1756-DNB scanner module must be powered up before proceeding with the USB driver setup.

To connect your 1756-DNB scanner module via a USB port, you need to first set up a USB driver. To set up a USB driver, perform this procedure.

1. Connect your 1756-DNB scanner module via a USB port.

The Found New Hardware Wizard dialog appears.



2. Check Install the software automatically (Recommended).
3. Click Next.

These dialogs appear consecutively.

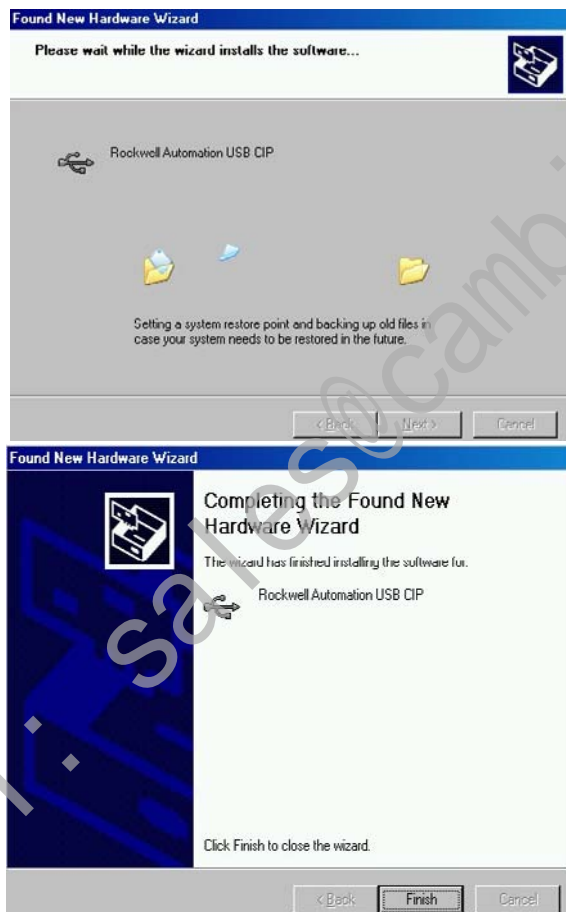

4. Click Finish to set up your USB driver.

- In RSLinx software, from the Communications pull-down menu, choose RSWho to view your module.

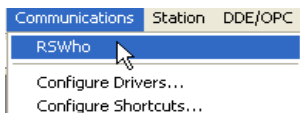

The RSLinx Workstation organizer appears.

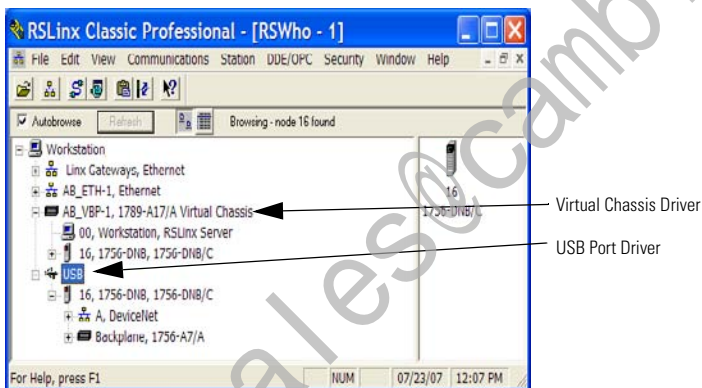

Your module appears under two different drivers, a virtual chassis and the USB port. You can use either driver to browse through your 1756-DNB scanner module.

### Flash Upgrade Firmware through a USB Port

You may flash upgrade the firmware for one module through a USB port.

#### IMPORTANT

The 1756-DNB scanner module must be powered up before proceeding with the flash upgrade.

**IMPORTANT**

Do not simultaneously flash upgrade the firmware for more than one module through a USB port. If you do, one or more of the flash updates may fail in the middle of the download.

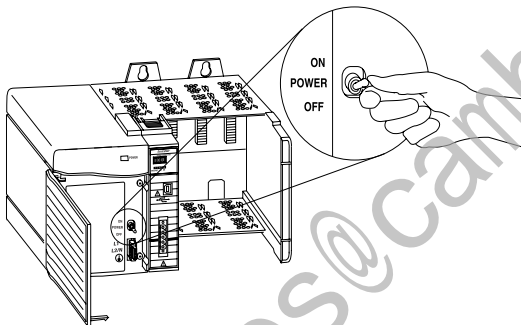
**Apply Chassis Power**

31717-M



## Check Power Supply and Module Status

Check the status indicators and alphanumeric display to determine if the power supply and module are operating properly. See Monitor and Troubleshoot Devices in the Module Scan List on [page 27](#).

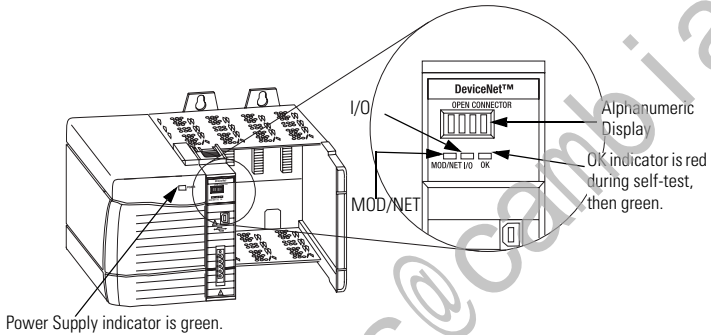

When you apply chassis power, the alphanumeric display cycles through the following information:

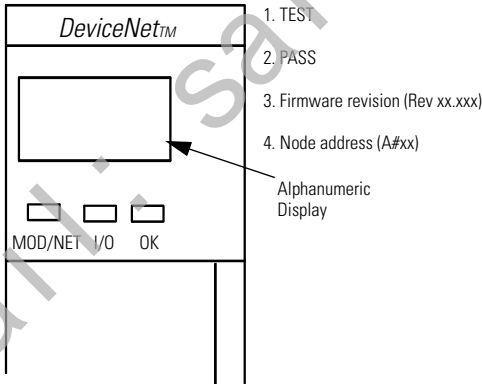

For more information on the alphanumeric display or status codes, see Monitor and Troubleshoot Devices in the Module Scan List on [page 27](#).

## Install or Remove the Module Under Power

You can install or remove this module while chassis power is applied.

---

**WARNING**

When you insert or remove the module while backplane power is on, an electrical arc can occur. This could cause an explosion in hazardous location installations. Be sure that power is removed or the area is nonhazardous before proceeding. Repeated electrical arcing causes excessive wear to contacts on both the module and its mating connector. Worn contacts may create electrical resistance that can affect module operation.

---

## Remove or Replace the Module

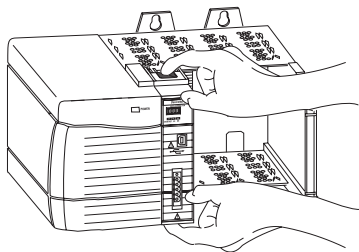

1  
Push on upper and lower module tabs to disengage them.

31719-M

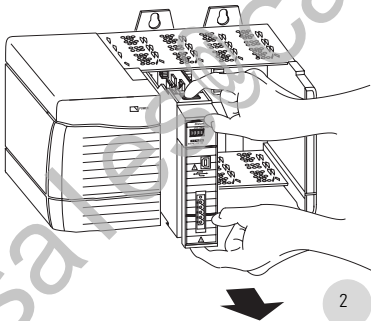

2  
Slide module out of chassis.

31720-M

**IMPORTANT**

If you want to replace an existing module with an identical one, and you want to resume identical system operation, you must install the new module in the same slot.

## Configure the Scan List

Use RSNetWorx for DeviceNet software to configure the scan list for the 1756-DNB scanner module.

Refer to DeviceNet Modules in Logix5000 Control Systems, publication [DNET-UM004](#).

## Monitor and Troubleshoot Devices in the Module Scan List

Use the alphanumeric display and the status indicators on the 1756-DNB scanner module front panel to verify networked devices in the scan list are operating correctly.

### Interpret the Alphanumeric Display

Your 1756-DNB scanner module displays alphanumeric codes that provide diagnostic information about your module. The alphanumeric display flashes the codes at approximately one-second intervals.

As an example, the display for RUN toggles between the node address and the mode of the 1756-DNB scanner module:

A#01  
RUN

If there is a problem, the display shows the MAC ID of the problem node, then the error code. The display toggles through these elements until the error is corrected:

A#01  
RUN  
N#33  
E#72

*Alphanumeric Status Messages*

The following table summarizes the status messages.

**Alphanumeric Status Message**

<b>Status Message</b>	<b>Description</b>
Run	The 1756-DNB scanner module is in Run mode.
Idle	The 1756-DNB scanner module is in Idle mode.
Auto	AutoScan is enabled and the 1756-DNB scanner module is in Idle mode.
Flash In Progress	ControlFlash is transferring a flash image to the 1756-DNB scanner module.
Duplicate Node Failure	The node address of the 1756-DNB scanner module is already in use by another device on the DeviceNet network.
Bus Off Detected	The 1756-DNB scanner module has detected errors on the DeviceNet network and has been taken offline.
No Network Power	No DeviceNet network power is being supplied to the 1756-DNB scanner module.
NoRX	- The 1756-DNB scanner module does not contact a scanlist. - The 1756-DNB scanner module has not received communication from any other device.
NoTX	The 1756-DNB module failed to transmit a message.
Reset Complete - Change Switch Settings	Factory default settings for the 1756-DNB module have been restored. Set the data rate and node address rotary switches to the desired position and restore power to the module.

*DeviceNet Status Codes*

The following table summarizes the codes.

**DeviceNet Status Codes**

<b>Status Code</b>	<b>Description of Status</b>	<b>Recommended Action</b>
0..63	Scanner's DeviceNet node address.	None.
65	The AutoScan option is on and the device is in Idle mode.	None.
67	Scanner is secondary scanner.	None.
68	Primary scanner has detected no secondary scanner.	Configure another scanner to be the secondary scanner.
69	Primary and secondary configurations are mismatched.	Check configuration of the secondary scanner.
70	The address of the device is already in use by another device on the network. The scanner failed the duplicate node address check.	Change the address of the device to an unused address.
71	Invalid data in scan list.	Use RSNetWorx for DeviceNet software to reconfigure the scan list.
72	Slave device stopped communicating. If the slave device does not recover communication during next scan, status code changes to 78.	Verify slave device's: <ul style="list-style-type: none"> <li>• power.</li> <li>• communication connections.</li> </ul> If slave device is polled, verify that interscan delay time is adequate for the device to return data.
73	Slave device's identity information does not match electronic key in scanner.	<ul style="list-style-type: none"> <li>• Make sure that the correct device is connected at this address.</li> <li>• Make sure that the device matches the specified electronic key (vendor, product code, and product type).</li> </ul>

**DeviceNet Status Codes**

<b>Status Code</b>	<b>Description of Status</b>	<b>Recommended Action</b>
74	Scanner detected data overrun on DeviceNet communication port.	<ul style="list-style-type: none"><li>• Modify your configuration and check for invalid data.</li><li>• Check network communication traffic.</li></ul>
75	Either or both of the following: <ul style="list-style-type: none"><li>• The device does not have a scan list.</li><li>• The device has not received communication from any other device.</li></ul>	Verify that the device has a: <ul style="list-style-type: none"><li>• configured scan list.</li><li>• properly-wired connection to the network.</li></ul>
76	No direct network traffic for scanner. The scanner hears other network communication but does not hear any directed to it.	None.
77	During initialization, the data size expected by the device does not match the scan list entry.	Use RSNetWorx for DeviceNet software to check the slave device and the scan list for the correct input and output sizes for the slave device.

## DeviceNet Status Codes

Status Code	Description of Status	Recommended Action
78	Device is configured in scan list, but not communicating. It has failed to communicate during the scanner's second scan, which followed the display of status error code 72.	<p>Verify device's:</p> <ul style="list-style-type: none"> <li>• power.</li> <li>• communication connections.</li> </ul> <p>If the device is polled, make sure the interscan delay is long enough for the device to return its data.</p> <p>If necessary, use RSNetWorx for DeviceNet software to do the following.</p> <ul style="list-style-type: none"> <li>• Add the device to the DeviceNet network.</li> <li>• Delete the device from scanner's scan list.</li> <li>• Inhibit the device in the scanner's scan list.</li> </ul>
79	Scanner has failed to transmit a message. The error status usually displays after the duplicate node check completes when power is applied to the module.	<ul style="list-style-type: none"> <li>• Make sure that your scanner is connected to a valid network.</li> <li>• Check for disconnected cables.</li> <li>• Verify the network communication rate.</li> </ul>
80	Scanner is in Idle mode.	<ol style="list-style-type: none"> <li>1. Put the controller in Run or Remote Run mode using the keyswitch on the controller, or through RSLogix5000 software.</li> <li>2. Turn on the bit <code>O.CommandRegister.Run</code> for the scanner.</li> </ol>
81	Controller has set the scanner to the faulted mode. The Command bit also indicates a DeviceNet network fault state.	Bit <code>O.CommandRegister.Fault</code> for the scanner is on. Correct the condition that caused controller to set this bit and then turn this bit off.



**DeviceNet Status Codes**

<b>Status Code</b>	<b>Description of Status</b>	<b>Recommended Action</b>
82	Error detected in sequence of fragmented I/O messages from device.	Use RSNetWorx for DeviceNet software to: <ul style="list-style-type: none"> <li>• check scan list of the device to make sure that its input and output data sizes are correct.</li> <li>• check the configuration of the device.</li> </ul>
83	Device returns error responses when the scanner attempts to communicate with it.	<ul style="list-style-type: none"> <li>• Use RSNetWorx for DeviceNet software to:               <ul style="list-style-type: none"> <li>– check the accuracy of the scan list.</li> <li>– check the configuration of the device. The device may be in another scanner's scan list.</li> </ul> </li> <li>• Use the slave device's documentation to verify that the device supports the message type used by the scanner.               <ul style="list-style-type: none"> <li>– If the device's message type does not match the scanner's, then use RSNetWorx for DeviceNet software to access the scanner's scanlist and change the scanner's message type to one that is compatible with the slave device.</li> </ul> </li> <li>• Cycle power to the device.</li> </ul>
84	Scanner is initializing the DeviceNet network.	None. This code clears itself once the scanner attempts to initialize all the devices on the network.

**DeviceNet Status Codes**

<b>Status Code</b>	<b>Description of Status</b>	<b>Recommended Action</b>
85	During runtime, the data size sent by the slave device does not match the size in the corresponding scan list entry.	Since variable length poll data is not supported, verify that the slave device is functioning properly.
86	The device is in Idle mode, or not producing data, while the scanner is in Run mode.	<ul style="list-style-type: none"> <li>• Check the configuration and status of the device.</li> <li>• If you set up an interlock between 2 scanners (controllers), make sure both scanners are in Run mode.</li> </ul>
87	Scanner cannot listen to shared inputs from slave device because the owning scanner has not established communication with that slave device.	<ul style="list-style-type: none"> <li>• Verify primary scanner connection and configuration.</li> <li>• Verify that the slave device is producing data.</li> </ul>
88	Scanner cannot listen to shared inputs from slave device because I/O parameters (for example, polled or strobed, electronic key, data size) for that slave device are configured differently between this scanner and the owning scanner.	In this scanner, reconfigure the I/O parameters for the shared inputs scan list entry so that they match those same parameters in the owning scanner.
89	Scanner failed to configure a device using the Automatic Device Recovery (ADR) parameters.	<ul style="list-style-type: none"> <li>• Make sure that you installed a compatible device.</li> <li>• If the offline configuration of the device does not match the actual (online) configuration of the device, change the offline configuration to match the online configuration.</li> </ul>
90	Controller has set the scanner to the Disabled mode.	If desired, enable the scanner by locating the O.CommandRegister.DisableNetwork bit on the command register and turning it off.

**DeviceNet Status Codes**

<b>Status Code</b>	<b>Description of Status</b>	<b>Recommended Action</b>
91	Bus-off condition likely due to cable or signal errors.	<ul style="list-style-type: none"> <li>• Cycle power to the device.</li> <li>• Verify that all devices are set to the same communication rate.</li> <li>• Check DeviceNet cabling to make sure no short circuits exist between CAN (blue and white) wires and power or shield (black, red, and shield) wires.</li> <li>• Check the media system for the following noise sources.               <ul style="list-style-type: none"> <li>– Device located near high-voltage power cable.</li> <li>– Incorrect or no termination resistor used.</li> <li>– Improper grounding.</li> <li>– Device on network producing noise or incorrect data for the network.</li> </ul> </li> </ul>
92	DeviceNet cable not supplying power to the device's communication port.	<ul style="list-style-type: none"> <li>• Verify the network's 24V DC power supply is operating properly.</li> <li>• Verify good cable condition.</li> <li>• Check cable connections to the device.</li> </ul>
95	A device's firmware is being updated or a configuration is being downloaded.	None. Do not disconnect the device while the update is in process because existing data in device memory will be lost.
96	Communication port is in test mode.	None.

## DeviceNet Status Codes

Status Code	Description of Status	Recommended Action
97	The controller has placed the scanner in halt mode.	If the O.CommandRegister.HaltScanner bit is on, turn it off. Then cycle scanner power.
98	General firmware error.	Replace device.
99	System failure.	Replace device.

## Interpret the Status Indicators

The status indicators on the module provide information about your network and its connections. The following tables outline the indicator condition and corresponding status and explain what each condition means:

- **Module/Network (MOD/NET) Status Indicator** - This bi-color (green/red) status indicator provides device and communication status.
- **I/O Status Indicator** - This bi-color (green/red) status indicator indicates the status of the 1756-DNB scanner module's I/O scanning state. The I/O status indicator informs you whether this device has outputs under control and whether any outputs or inputs are active (such as outputs active and inputs producing) or faulted. The I/O status indicator reflects the mod/state of the inputs and outputs, not necessarily the on/off condition of the I/O points themselves.
- **OK Status Indicator** - This bi-color (green/red) status indicator indicates whether the device has power and is operating properly.

**Indicator State and Description**

Indicator	State	Description
Module/ Network (MOD/NET)	Off	<p>Device is not powered/not online.</p> <ul style="list-style-type: none"> <li>• The device has not completed the Dup_MAC_ID test yet.</li> <li>• The device may not be powered.</li> </ul>
	Green	<p>Device is operating in a normal condition and is online with connections established.</p> <ul style="list-style-type: none"> <li>• For a Group 2 Only device, this means the device is allocated to a Master.</li> <li>• For a UCMM capable device, this means the device has one or more established connections.</li> </ul>
	Flashing green <sup>(1)</sup>	<p>Device is operational AND online and not connected or device online and device needs commissioning. The device is operating in a normal condition and is online with no connections established.</p> <ul style="list-style-type: none"> <li>• The device has passed the Dup_MAC_ID test, is online, but has no established connections to other nodes.</li> <li>• For a Group 2 only device, this means the device is not allocated to a master.</li> <li>• For a UCMM capable device, this means that the device has no established connections.</li> <li>• Configuration missing, incomplete, or incorrect.</li> </ul>

<sup>(1)</sup> The flash rate of the status indicator is approximately 1 flash per second. The status indicator should be on for approximately 0.5 seconds and off for approximately 0.5 seconds.

Indicator	State	Description
Module/ Network (MOD/NET)	Flashing red <sup>(1)</sup>	Minor fault and/or connection time-out - recoverable fault and/or one or more I/O connections are in the timed-out state.
	Red	Critical fault or critical link failure - device has an unrecoverable fault and may need to be replaced.  Failed communication device. The device has detected an error (duplicate MAC ID or bus-off) that has rendered it incapable of communicating on the network.
I/O	Off	Scanner is not online. Check network power.
	Green	Scanner is in RUN mode, outputs are under control, and inputs are being consumed.
	Flashing green <sup>(1)</sup>	Scanner is in IDLE mode, outputs are <b>not</b> under control, and inputs are being consumed.
OK	Off	No power applied to device. Apply chassis power. Verify module is completely inserted into chassis and backplane.
	Green	Device is operating normally. The 1756-DNB scanner module has at least one connection to it from a controller.
	Flashing green <sup>(2)</sup>	The device is operating correctly; however, no controller is controlling it. Verify that the 1756-DNB scanner module is properly configured in the controller's I/O configuration.
	Red	Device has an unrecoverable fault; repair or replace it, or Device is in self test during power-up.

<sup>(1)</sup> The flash rate of the status indicator is approximately 1 flash per second. The status indicator should be on for approximately 0.5 seconds and off for approximately 0.5 seconds.

<sup>(2)</sup> The flash rate of the status indicator is approximately 1 flash per second. The status indicator should be on for approximately 0.5 seconds and off for approximately 0.5 seconds.

## Understand ControlLogix Controller Interface Structures

The 1756-DNB scanner module supports several sizes of input, output, and status structures over the ControlLogix backplane. These I/O structures were created to reduce the complexity of connecting DeviceNet I/O and status data with ladder programs.

The module creates all three structures whether DeviceNet devices are configured or online.

RSLogix 5000 software directs the controller to connect to these predefined default I/O structures. The controller automatically performs periodic updates of the structures on a cyclic basis.

RSNetWorx for DeviceNet software configures scanlist map segments that are used to copy specific portions of I/O data between the I/O structures and DeviceNet network packets.

### IMPORTANT

Only one Logix controller at a time can send outputs to the 1756-DNB scanner module.

## Output Structure

The controller controls output I/O by writing output data to an output structure in the 1756-DNB scanner module. The scanner module then delivers a copy of these output values to modules on DeviceNet. The output structure consists of a 32-bit command register and a variable size 32-bit array of up to 123 words for output data.

Output Structure Element	Description	Data Type
module command register	This 32-bit register consists of several bits that affect the module's behavior on the network.	1 x 32-bit register
output_data		123 x 32-bit data array

## Module Command Register Bit Definitions

The bits of the Module Command Register are defined as follows.

Bit	Name	Description
0	Run	1 = run mode 0 = idle mode
1	Fault	1 = fault network
2	DisableNetwork	1 = disable network
3	HaltScanner	1 = halt module (the 1756-DNB scanner module ceases all operation.)
4	Reset	1 = reset module (put back to 0 to resume operation.)
5...31	Reserved	Unused

**IMPORTANT**

If the module is halted because the HaltScanner bit is set, power must be physically recycled to restart the module.



## Input Structure

The controller receives input I/O by reading input data from an input structure in the 1756-DNB scanner module. The scanner module receives input data from DeviceNet modules and delivers a copy of these values to the controller. The input structure consists of one 32-bit status register and a variable size 32-bit array of up to 124 words for input data. The 32-bit status register reflects the current state of several key module-level operational parameters.

The input structure consists of these data elements.

<b>Input Structure Element</b>	<b>Data Type</b>
module status register	1 x 32-bit register
input_data	123 x 32-bit variable size data array

## Module Status Register Bit Definitions

The Module Status Register bits are defined as follows

Bit	Name	Description
0	Run	1 = in Run mode 0 = in Idle mode
1	Fault	1 = Network is faulted
2	DisableNetwork	1 = Network is disabled
3	DeviceFailure	1 = Device failure exists (examine the status structure for causes)
4	AutoverifyFailure	1 = At least one device has failed to be initialized by the scanner
5	CommFailure	1 = Communication failure exists
6	DupNodeFail	1 = Failure due to duplicate node address
7	DnetPowerDetect	1 = DeviceNet power failure
8	NetworkWarning	1 = Scanner has detected numerous receive and/or transmit errors -- check the integrity of the DeviceNet network
9...31	{Reserved}	Unused

## Status Structure

The controller receives status information concerning the 1756-DNB scanner module's ability to exchange DeviceNet messages with other nodes by reading from the status structure in the 1756-DNB scanner module. The scanner module periodically updates the contents of the status structure and copies its contents to the controller. The status structure consists of several tables. The bit position of each of the 64 bits that make up a given status table directly corresponds to the node address of a device.

The status structure consists of these data elements.

Status Structure Element	Description	Data Type	DINTS
ScanCounter	Counter incremented each I/O scan	32-bit	10
DeviceFailureRegister	Device failed bit table; 1 = failed	64-bit	
AutoverifyFailureRegister	Device I/O size does not match scanner's internal table; 1 = mismatch	64-bit	
DeviceIdleRegister	Device is idle bit table; 1 = idle	64-bit	
ActiveNodeRegister	Node online bit table; 1 = online	64-bit	
StatusDisplay	ASCII representation of scanner module alphanumeric display	4-byte	
ScannerDeviceStatus	Scanner device status:	4-byte binary	11
ScannerAddress	DeviceNet address of 1756-DNB scanner module	8-bit binary	
ScannerStatus	Status of 1756-DNB scanner module	8-bit binary	
ScrollingDeviceAddress	Scrolls through DeviceNet nodes once per s by address and status (0 = no faults).	8-bit binary	
ScrollingDeviceStatus		8-bit binary	
ReservedArray	Future expansion (20 bytes)	20 x 8-bit	16
DeviceStatus	DeviceNet node status array, byte per device	64 x 8-bit	24/32

## Specifications

### ControlLogix DeviceNet Scanner Module, Cat. No. 1756-DNB

Attribute	Value
Module location	Any slot in the ControlLogix chassis
DeviceNet communication rate, max	125 Kbps - 500 m (1640 ft.) max 250 Kbps - 250 m (820 ft.) max 500 Kbps - 100 m (328 ft.) max
Backplane current (mA) at 5.1V DC	850 mA
Backplane current (mA) at 24V DC	3 mA
DeviceNet current (mA), max	11...25V DC (60 mA max)
Isolation voltage, continuous	30V (continuous), Basic Insulation Type No isolation between USB and system Tested at 500V AC for 60 s, DeviceNet to system
Enclosure type rating	None (open-style)
Conductors Wire size Category	Refer to the DeviceNet Media Design and Planning Guide, publication <a href="#">DNET-UM072</a> , for information specific to your DeviceNet network. <sup>(1)</sup>
North American temp code	T4A
IEC temp code	T4
Power dissipation, max	5.8 W
Thermal dissipation, max	19.8 BTU/hr
Recommended USB cable for USB port	Samtec cable, PN RSP-119350

##### **ControlLogix DeviceNet Scanner Module, Cat. No. 1756-DNB**

USB port	USB 1.1 USB Device USB Series B Receptacle
DeviceNet connector torque	0.56...0.79 Nm (5...7 in-lb)
Power supply	To comply with the CE Low Voltage Directive (LVD), DeviceNet network must be powered from a source compliant with the following: Safety Extra Low Voltage (SELV) or Protected Extra Low Voltage (PELV). To comply with UL restrictions, DeviceNet network must be powered from a source compliant with the following: Class 2 or Limited Voltage/Current.

<sup>(1)</sup> Use this Conductor Category information for planning conductor routing. Refer to Industrial Automation Wiring and Grounding Guidelines, publication [1770-4.1](#).

## Environmental Specifications

Attribute	Value
Temperature, operating	IEC 60068-2-1 (Test Ad, Operating Cold), IEC 60068-2-2 (Test Bd, Operating Dry Heat), IEC 60068-2-14 (Test Nb, Operating Thermal Shock): 0...60 °C (32...140 °F)
Temperature, nonoperating	IEC 60068-2-1 (Test Ab, Unpackaged Nonoperating Cold), IEC 60068-2-2 (Test Bb, Unpackaged Nonoperating Dry Heat), IEC 60068-2-14 (Test Na, Unpackaged Nonoperating Thermal Shock): -40...85 °C (-40...185 °F)
Relative humidity	IEC 60068-2-30 (Test Db, Unpackaged Damp Heat): 5...95% noncondensing
Vibration	IEC 60068-2-6 (Test Fc, Operating): 2 g @ 10...500 Hz
Shock, operating	IEC 60068-2-27 (Test Ea, Unpackaged Shock): 30 g
Shock, nonoperating	IEC 60068-2-27 (Test Ea, Unpackaged Shock): 50 g
Emissions	CISPR 11: Group 1, Class A
ESD immunity	IEC 61000-4-2: 6 kV contact discharges 8 kV air discharges
Radiated RF immunity	IEC 61000-4-3: 10V/m with 1 kHz sine-wave 80%AM from 80...2000 MHz 10V/m with 200 Hz 50% Pulse 100%AM at 900 MHz 10V/m with 200 Hz 50% Pulse 100%AM at 1890 MHz 1V/m with 1 kHz sine-wave 80%AM from 2000...2700 MHz
EFT/B immunity	IEC 61000-4-4: ±3 kV at 5 kHz on DeviceNet port
Surge transient immunity	IEC 61000-4-5: ±2 kV line-earth(CM) on DeviceNet port
Conducted RF Immunity	IEC 61000-4-6: 10V rms with 1 kHz sine-wave 80%AM from 150 kHz...80 MHz

## Certifications

Certification	Value	
Certifications <sup>(1)</sup> (when product is marked)	UL	UL Listed Industrial Control Equipment. See UL File E65584.
	UL	UL Listed for Class I, Division 2 Group A,B,C,D Hazardous Locations. See UL File E194810.
	c-UL-us	UL Listed Industrial Control Equipment, certified for US and Canada. See UL File E65584.
	c-UL-us	UL Listed for Class I, Division 2 Group A,B,C,D Hazardous Locations, certified for U.S. and Canada. See UL File E194810.
	CSA	CSA Certified Process Control Equipment. See CSA File LR54689C
	CSA	CSA Certified Process Control Equipment for Class I, Division 2 Group A,B,C,D Hazardous Locations. See CSA File LR69960C.
	FM	FM Approved Equipment for use in Class I Division 2 Group A,B,C,D Hazardous Locations
	EEx	European Union 94/9/EC ATEX Directive, compliant with: EN 60079-15; Potentially Explosive Atmospheres, Protection "n" (Zone 2)
	CE	European Union 2004/108/EC EMC Directive, compliant with: EN 61326-1; Meas./Control/Lab., Industrial Requirements EN 61000-6-2; Industrial Immunity EN 61000-6-4; Industrial Emissions EN 61131-2; Programmable Controllers (Clause 8, Zone A & B)
	C-Tick	Australian Radiocommunications Act, compliant with: AS/NZS CISPR 11; Industrial Emissions
ODVA	ODVA conformance tested to DeviceNet specifications	

<sup>(1)</sup> See the Product Certification link at <http://ab.com> for Declarations of Conformity, Certificates, and other certification details.

## Additional Resources

These documents contain additional information concerning related Rockwell Automation products.

Resource	Description
Logix5000 Controllers Common Procedures Reference Manual, publication <a href="#">1756-PM001</a>	Developing projects for Logix5000 controllers
Logix5000 Controllers General Instructions Reference Manual, publication <a href="#">1756-RM003</a>	Programming the controller for sequential applications
Logix5000 Controllers Process Control and Drives Instructions Reference Manual, publication <a href="#">1756-RM006</a>	Programming the controller for process or drives applications
DeviceNet Media Design and Installation Guide, publication <a href="#">DNET-UM072</a>	Planning and installing a DeviceNet network
DeviceNet Modules in Logix5000 Control Systems, publication <a href="#">DNET-UM004</a>	Programming, configuring, using, and troubleshooting DeviceNet modules
Industrial Automation Wiring and Grounding Guidelines, publication <a href="#">1770-4.1</a>	Grounding and wiring Allen-Bradley programmable controllers
National Electrical Code - Published by the National Fire Protection Association of Boston, MA.	Wire sizes and types for grounding electrical equipment

You can view or download publications at <http://www.literature.rockwellautomation.com>. To order paper copies of technical documentation, contact your local Rockwell Automation distributor or sales representative.



## Rockwell Automation Support

Rockwell Automation provides technical information on the Web to assist you in using its products. At <http://support.rockwellautomation.com>, you can find technical manuals, a knowledge base of FAQs, technical and application notes, sample code and links to software service packs, and a MySupport feature that you can customize to make the best use of these tools.

For an additional level of technical phone support for installation, configuration, and troubleshooting, we offer TechConnect support programs. For more information, contact your local distributor or Rockwell Automation representative, or visit <http://support.rockwellautomation.com>.

## Installation Assistance

If you experience a problem within the first 24 hours of installation, please review the information that's contained in this manual. You can also contact a special Customer Support number for initial help in getting your product up and running.

United States	1.440.646.3434 Monday – Friday, 8 a.m. – 5 p.m. EST
Outside United States	Please contact your local Rockwell Automation representative for any technical support issues.

## New Product Satisfaction Return

Rockwell Automation tests all of its products to ensure that they are fully operational when shipped from the manufacturing facility. However, if your product is not functioning and needs to be returned, follow these procedures.

United States	Contact your distributor. You must provide a Customer Support case number (call the phone number above to obtain one) to your distributor in order to complete the return process.
Outside United States	Please contact your local Rockwell Automation representative for the return procedure.

Allen-Bradley, ControlLogix, Rockwell Automation, RSLogix 5000, ControlFlash, and RSLinx are trademarks of Rockwell Automation, Inc.

Trademarks not belonging to Rockwell Automation are property of their respective companies.

[www.rockwellautomation.com](http://www.rockwellautomation.com)

### Power, Control and Information Solutions Headquarters

Americas: Rockwell Automation, 1201 South Second Street, Milwaukee, WI 53204-2496 USA, Tel: (1) 414.582.2000, Fax: (1) 414.582.4444

Europe/Middle East/Africa: Rockwell Automation, Vorstlaan/Boulevard du Souverain 36, 1170 Brussels, Belgium, Tel: (32) 2 665 0800, Fax: (32) 2 665 0840

Publication 1756-IN566D-EN-P - June 2008

PN-27687

Supersedes Publication 1756-IN566C-EN-P - August 2007

Copyright © 2008 Rockwell Automation, Inc. All rights reserved. Printed in the U.S.A.